

**Use & Care Guide**  
**Manual de uso y cuidado**  
**Guide d'utilisation et d'entretien**  
English / Español / Français

Models/Modelos/Modèles: 106.4112\*, 106.4115\*

# Kenmore®

## Side by Side Refrigerator Refrigerador de dos puertas Réfrigérateur côte à côte

\* = color number, número de color, le numéro de la couleur

P/N W10436750B  
Sears Brands Management Corporation  
Hoffman Estates, IL, U.S.A. 60179  
[www.kenmore.com](http://www.kenmore.com)  
[www.sears.com](http://www.sears.com)

Sears Canada Inc.  
Toronto, Ontario, Canada M5B 2C3  
[www.sears.ca](http://www.sears.ca)



# TABLE OF CONTENTS

<b>PROTECTION AGREEMENTS</b> .....	<b>2</b>	Convertible Vegetable/Meat Drawer, Crisper and Covers....	10
<b>WARRANTY</b> .....	<b>3</b>	Convertible Vegetable/Meat Drawer Temperature Control...	11
<b>REFRIGERATOR SAFETY</b> .....	<b>4</b>	Crisper Humidity Control .....	11
Proper Disposal of Your Old Refrigerator .....	5	<b>FREEZER FEATURES</b> .....	<b>11</b>
<b>INSTALLATION INSTRUCTIONS</b> .....	<b>5</b>	Freezer Shelf .....	11
Unpack the Refrigerator .....	5	Freezer Bin .....	12
Door Removal, Leveling and Alignment.....	6	<b>DOOR FEATURES</b> .....	<b>12</b>
Handle Installation and Removal.....	8	Door Bins.....	12
Location Requirements.....	8	Door Rails or Bins .....	12
Electrical Requirements .....	9	<b>REFRIGERATOR CARE</b> .....	<b>12</b>
<b>REFRIGERATOR USE</b> .....	<b>9</b>	Cleaning.....	12
Ensuring Proper Air Circulation.....	9	Lights.....	13
Using the Controls .....	9	Power Interruptions .....	13
<b>REFRIGERATOR FEATURES</b> .....	<b>10</b>	Vacation and Moving Care .....	13
Refrigerator Shelves.....	10	<b>PROBLEM SOLVER</b> .....	<b>14</b>
Deli Drawer.....	10	<b>ACCESSORIES</b> .....	<b>16</b>
		<b>SERVICE NUMBERS</b> .....	<b>BACK COVER</b>
		<b>ÍNDICE</b> .....	<b>18</b>
		<b>TABLE DES MATIÈRES</b> .....	<b>35</b>

## PROTECTION AGREEMENTS

### Master Protection Agreements

*Congratulations on making a smart purchase.* Your new Kenmore® product is designed and manufactured for years of dependable operation. But like all products, it may require preventive maintenance or repair from time to time. That's when having a Master Protection Agreement can save you money and aggravation.

The Master Protection Agreement also helps extend the life of your new product. Here's what the Agreement\* includes:

- ✓ **Parts and labor** needed to help keep products operating properly **under normal use**, not just defects. Our coverage goes **well beyond the product warranty**. No deductibles, no functional failure excluded from coverage— **real protection**.
- ✓ **Expert service** by a force of more than 10,000 authorized **Sears service technicians**, which means someone you can trust will be working on your product.
- ✓ **Unlimited service calls and nationwide service**, as often as you want us, whenever you want us.
- ✓ **"No-lemon" guarantee** – replacement of your covered product if four or more product failures occur within twelve months.
- ✓ **Product replacement** if your covered product can't be fixed.
- ✓ **Annual Preventive Maintenance Check** at your request – no extra charge.
- ✓ **Fast help by phone** – we call it **Rapid Resolution** – phone support from a Sears representative on all products. Think of us as a "talking owner's manual."

- ✓ **Power surge protection** against electrical damage due to power fluctuations.
- ✓ **\$250 Food Loss Protection** annually for any food spoilage that is the result of mechanical failure of any covered refrigerator or freezer.
- ✓ **Rental reimbursement** if repair of your covered product takes longer than promised.
- ✓ **10% discount** off the regular price of any non-covered repair service and related installed parts.

Once you purchase the Agreement, a simple phone call is all that it takes for you to schedule service. You can call anytime day or night, or schedule a service appointment online.

The Master Protection Agreement is a risk free purchase. If you cancel for any reason during the product warranty period, we will provide a full refund. Or, a prorated refund anytime after the product warranty period expires. Purchase your Master Protection Agreement today!

**Some limitations and exclusions apply. For prices and additional information in the U.S.A. call 1-800-827-6655.**

**\*Coverage in Canada varies on some items. For full details call Sears Canada at 1-800-361-6665.**

### Sears Installation Service

For Sears professional installation of home appliances, garage door openers, water heaters, and other major home items, in the U.S.A. or Canada call **1-800-4-MY-HOME®**.

# KENMORE APPLIANCE WARRANTY

## ONE YEAR LIMITED WARRANTY

When installed, operated and maintained according to all instructions supplied with the product, if this appliance fails due to a defect in material or workmanship within one year from the date of purchase, call 1-800-4-MY-HOME® to arrange for free repair.

This warranty applies for only 90 days from the date of purchase if this appliance is ever used for other than private family purposes.

## THIS WARRANTY COVERS ONLY DEFECTS IN MATERIAL AND WORKMANSHIP. SEARS WILL NOT PAY FOR:

1. Expendable items that can wear out from normal use, including but not limited to filters, belts, incandescent light bulbs, and bags.
2. A service technician to instruct the user in correct product installation, operation or maintenance.
3. A service technician to clean or maintain this product.
4. Damage to or failure of this product if it is not installed, operated or maintained according to all instructions supplied with the product.
5. Damage to or failure of this product resulting from accident, abuse, misuse or use for other than its intended purpose.
6. Damage to or failure of this product caused by the use of detergents, cleaners, chemicals or utensils other than those recommended in all instructions supplied with the product.
7. Damage to or failure of parts or systems resulting from unauthorized modifications made to this product.

## DISCLAIMER OF IMPLIED WARRANTIES; LIMITATION OF REMEDIES

Customer's sole and exclusive remedy under this limited warranty shall be product repair as provided herein. Implied warranties, including warranties of merchantability or fitness for a particular purpose, are limited to one year or the shortest period allowed by law. Sears shall not be liable for incidental or consequential damages. Some states and provinces do not allow the exclusion or limitation of incidental or consequential damages, or limitations on the duration of implied warranties of merchantability or fitness, so these exclusions or limitations may not apply to you.

This warranty applies only while this appliance is used in the United States or Canada.

This warranty gives you specific legal rights, and you may also have other rights which vary from state to state.

**Sears Brands Management Corporation**  
**Hoffman Estates, IL 60179**

**Sears Canada Inc.**  
**Toronto, Ontario, Canada M5B 2C3**

## PRODUCT RECORD

Record your complete model number, serial number, and purchase date. You can find this information on the model and serial number label located on the product.

Have this information available to help you obtain assistance or service more quickly whenever you contact Sears concerning your appliance.

Model number \_\_\_\_\_

Serial number \_\_\_\_\_

Purchase date \_\_\_\_\_

**Save these instructions and your sales receipt for future reference.**

# REFRIGERATOR SAFETY

## Your safety and the safety of others are very important.

We have provided many important safety messages in this manual and on your appliance. Always read and obey all safety messages.



This is the safety alert symbol.

This symbol alerts you to potential hazards that can kill or hurt you and others.

All safety messages will follow the safety alert symbol and either the word "DANGER" or "WARNING."

These words mean:

**⚠ DANGER**

You can be killed or seriously injured if you don't immediately follow instructions.

**⚠ WARNING**

You can be killed or seriously injured if you don't follow instructions.

All safety messages will tell you what the potential hazard is, tell you how to reduce the chance of injury, and tell you what can happen if the instructions are not followed.

## IMPORTANT SAFETY INSTRUCTIONS

**WARNING:** To reduce the risk of fire, electric shock, or injury when using your refrigerator, follow these basic precautions:

- Plug into a grounded 3 prong outlet.
- Do not remove ground prong.
- Do not use an adapter.
- Do not use an extension cord.
- Disconnect power before servicing.
- Replace all parts and panels before operating.
- Remove doors from your old refrigerator.
- Use nonflammable cleaner.
- Keep flammable materials and vapors, such as gasoline, away from refrigerator.
- Use two or more people to move and install refrigerator.
- Disconnect power before installing ice maker (on ice maker kit ready models only).
- Use a sturdy glass when dispensing ice (on some models).
- Do not hit the refrigerator glass doors (on some models).

**SAVE THESE INSTRUCTIONS**

State of California Proposition 65 Warnings:

WARNING: This product contains one or more chemicals known to the State of California to cause cancer.

WARNING: This product contains one or more chemicals known to the State of California to cause birth defects or other reproductive harm.

## Proper Disposal of Your Old Refrigerator

### **⚠️ WARNING**

#### **Suffocation Hazard**

Remove doors from your old refrigerator.

Failure to do so can result in death or brain damage.

**IMPORTANT:** Child entrapment and suffocation are not problems of the past. Junked or abandoned refrigerators are still dangerous, even if they will sit for “just a few days.” If you are getting rid of your old refrigerator, please follow these instructions to help prevent accidents.

## Before You Throw Away Your Old Refrigerator or Freezer:

- Take off the doors.
- Leave the shelves in place so that children may not easily climb inside.

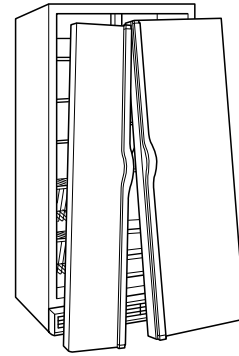

### **Important information to know about disposal of refrigerants:**

Dispose of refrigerator in accordance with Federal and Local regulations. Refrigerants must be evacuated by a licensed, EPA certified refrigerant technician in accordance with established procedures.

# INSTALLATION INSTRUCTIONS

## Unpack the Refrigerator

### **⚠️ WARNING**

#### **Excessive Weight Hazard**

Use two or more people to move and install refrigerator.

Failure to do so can result in back or other injury.

### **When Moving Your Refrigerator:**

Your refrigerator is heavy. When moving the refrigerator for cleaning or service, be sure to cover the floor with cardboard or hardboard to avoid floor damage. Always pull the refrigerator straight out when moving it. Do not wiggle or “walk” the refrigerator when trying to move it, as floor damage could occur.

## Remove the Packaging

- Remove tape and glue residue from surfaces before turning on the refrigerator. Rub a small amount of liquid dish soap over the adhesive with your fingers. Wipe with warm water and dry.
- Do not use sharp instruments, rubbing alcohol, flammable fluids, or abrasive cleaners to remove tape or glue. These products can damage the surface of your refrigerator. For more information see “Refrigerator Safety.”

## Clean Before Using

After you remove all of the packaging materials, clean the inside of your refrigerator before using it. See the cleaning instructions in “Refrigerator Care.”

### **Important information to know about glass shelves and covers:**

Do not clean glass shelves or covers with warm water when they are cold. Shelves and covers may break if exposed to sudden temperature changes or impact, such as bumping. Tempered glass is designed to shatter into many small, pebble-size pieces. This is normal. Glass shelves and covers are heavy. Use both hands when removing them to avoid dropping.

## Door Removal, Leveling and Alignment

Gather the required tools and parts and read all instructions before starting installation. Save these instructions for future reference.

**NOTE:** Before moving your product into your home, measure the doorway of your home to see whether you need to remove the refrigerator and freezer doors. If door removal is necessary, see the instructions below.

**IMPORTANT:** Before you begin, turn the refrigerator control OFF or turn cooling off. Unplug refrigerator or disconnect power. Remove food and any adjustable door or utility bins from doors.

### TOOLS NEEDED:

Bubble level; flat-blade screwdriver;  $\frac{5}{16}$ " wrench;  $\frac{1}{4}$ ",  $\frac{1}{2}$ ", and  $\frac{5}{16}$ " hex-head socket wrenches



## ⚠ WARNING

### Electrical Shock Hazard

Disconnect power before removing doors.  
Failure to do so can result in death or electrical shock.

### 2 Top Left Hinge

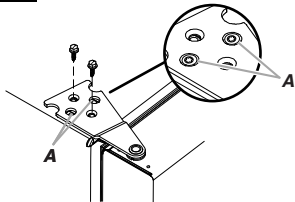

A. Do Not Remove Screws.

### 3 Door Removal



### 4 Top Right Hinge

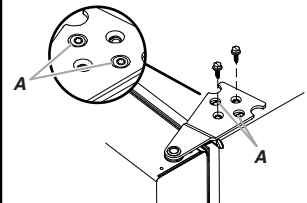

A. Do Not Remove Screws.

### 5 Bottom Hinges (Left and Right)

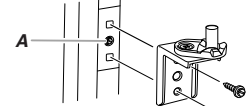

Do Not Remove Screw A (present on some models)

### 6 Leveling

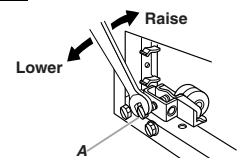

A. Leveling Screw

### 7 Door Alignment (Bottom Right Hinge)

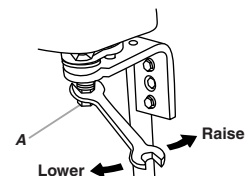

A. Alignment Screw

### 1 Base Grille

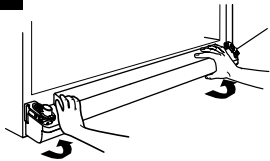

---

## Remove the Doors

---

### **WARNING**



#### Electrical Shock Hazard

Disconnect power before removing doors.

Failure to do so can result in death or electrical shock.

1. Unplug refrigerator or disconnect power.
2. Open both doors. Remove the base grille by pulling up on the bottom outside corners. *See Graphic 1.*
3. Close both doors and keep them closed until you are ready to lift them free from the cabinet.
4. Use a  $\frac{5}{16}$ " hex-head socket wrench to remove the top left hinge as shown. *See Graphic 2.*  
**IMPORTANT:** Do not remove either screw A.
5. Lift freezer door straight up off bottom hinge. *See Graphic 3.*  
**IMPORTANT:** Rest the door on its side on a soft, clean surface, such as a towel, blanket or piece of cardboard. This will help avoid damaging the door.
6. Remove top right hinge as shown. *See Graphic 4.*  
**IMPORTANT:** Do not remove either screw A.
7. Lift the refrigerator door straight up off bottom hinge.  
**IMPORTANT:** Rest the door on its side on a soft, clean surface, such as a towel, blanket or piece of cardboard. This will help avoid damaging the door.
8. It may not be necessary to remove the bottom hinges to move the refrigerator through a doorway. Both bottom hinges have similar construction.
  - If necessary, disassemble the hinges as shown. *See Graphic 5.*

**IMPORTANT:** To aid in door alignment and closing, there is a shim located between the hinge and the cabinet. When the hinge is removed, the shim may fall out of place. If this occurs, set the shim aside so it can be put back in place when the hinge is reconnected later.

---

## Replace the Doors and Hinges

---

1. Replace both bottom hinges, if removed. Make sure the shim is between the hinge and cabinet. Tighten screws.  
**NOTE:** Provide additional support for the doors while the top hinges are being replaced. Do not depend on the door magnets to hold the doors in place while you are working.
2. Align and replace the top left hinge as shown. *See Graphic 2.* Tighten screws.

3. Replace the refrigerator door by lifting the door onto the bottom right hinge.
4. Align and replace the top right hinge as shown. *See Graphic 4.* Tighten screws.
5. Replace any adjustable door or utility bins.
6. Plug into a grounded 3 prong outlet.

---

## Leveling and Door Closing

---

Your refrigerator has two front adjustable rollers — one on the right and one on the left. If your refrigerator seems unsteady or if you want the doors to close more easily, adjust the refrigerator's tilt using the instructions below:

1. Move the refrigerator into its final location.
2. Remove the base grille to locate the two leveling screws, which are part of the front roller assemblies on each side. *See Graphic 6.*

**NOTE:** Having someone push against the top of the refrigerator takes some weight off the leveling screws and rollers. This makes it easier to adjust the screws.

3. Use a  $\frac{1}{2}$ " hex-head socket wrench to adjust the leveling screws. Turn the leveling screw to the right to raise that side of the refrigerator or turn the leveling screw to the left to lower that side. It may take several turns of the leveling screws to adjust the tilt of the refrigerator. *See Graphic 6.*
4. Open both doors again and check that they close as easily as you like. If not, tilt the refrigerator slightly more to the rear by turning both leveling screws to the right. It may take several more turns, and you should turn both leveling screws the same amount.
5. Use a bubble level to check the leveling of the refrigerator.

**NOTE:** Whenever you need to move the refrigerator, turn the leveling feet to the right until they are no longer touching the ground. This will allow the refrigerator to roll more easily.

---

## Door Alignment

---

A refrigerator that is not level from side-to-side may appear to have doors that are not properly aligned. If the doors appear this way, use the instructions in the previous section to check the leveling.

The doors are designed to be slightly different heights when the refrigerator is empty, in order to account for the weight of food that will be placed on the doors. If the doors are still not aligned after checking the leveling and loading the refrigerator with food, follow the steps below to adjust the door alignment.

1. Locate the alignment screw on the bottom hinge of the refrigerator door. *See Graphic 7.*
2. Use a  $\frac{5}{16}$ " wrench to turn the screw. To raise the refrigerator door, turn the screw to the right. To lower the door, turn the screw to the left.
3. Check that the doors are even at the top and bottom. If necessary, continue to turn the alignment screw until the doors are aligned.
4. Replace the base grille.

**NOTE:** Be sure to refasten the Tech Sheet behind the base grille.

## Handle Installation and Removal

**PARTS INCLUDED:** Door handles (2), 1/8" hex key, spare setscrew(s)

### To Install the Handles:

**NOTE:** The handle mounting setscrews are preinstalled in the handle.

1. Remove the handles, which are packed inside the refrigerator.

**NOTE:** To avoid scratching the finish, place the handles on a towel or other soft surface.

2. Open the freezer door. On the refrigerator door, place the handle on the shoulder screws with the setscrews facing the freezer.

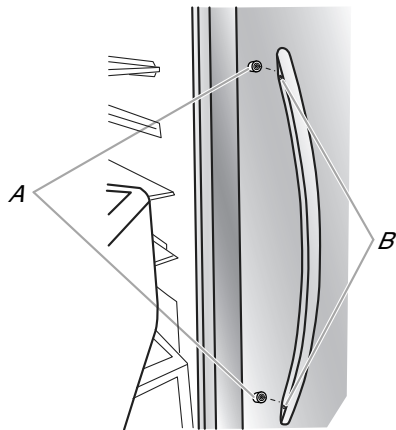

A. Shoulder screws

B. Setscrews inside the handle

3. Firmly push the handle toward the door until the handle base is flush against the door.
4. While holding the handle, insert the short end of the hex key into the upper hole and slightly rotate the hex key until it is engaged in the setscrew.

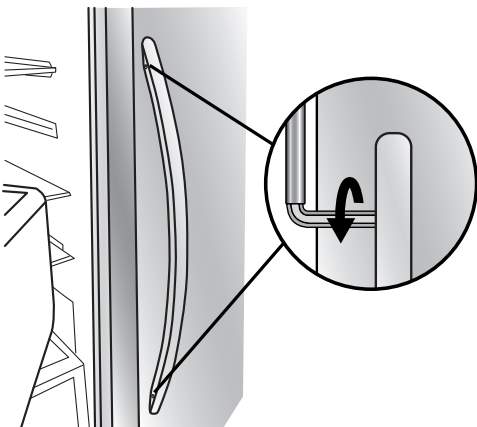

5. Using a clockwise motion, tighten the setscrew until it begins to contact the shoulder screw.
6. Repeat steps 4 and 5 to begin fastening the lower setscrew.
7. Once both setscrews have been partially tightened as outlined in the previous steps, fully tighten both the upper and lower setscrews.

**IMPORTANT:** When the screws feel tight, tighten them an additional quarter-turn. The handle is not properly installed without this extra tightening.

8. Open the refrigerator door and close the freezer door. Repeat steps 2 through 7 to install the other handle onto the freezer door with the setscrews facing the refrigerator.
9. Save the hex key and all instructions.

### To Remove the Handles:

1. While holding the handle, insert the short end of the hex key into the lower setscrew hole and slightly rotate the hex key until it is engaged in the setscrew.
2. Using a counterclockwise motion, loosen the setscrew a quarter-turn at a time.
3. Repeat steps 1 and 2 for the upper setscrew. Gently pull the handle away from the door.
4. If necessary, use a Phillips screwdriver to remove the shoulder screws from the door.

## Location Requirements

### ⚠ WARNING



#### Explosion Hazard

Keep flammable materials and vapors, such as gasoline, away from refrigerator.

Failure to do so can result in death, explosion, or fire.

**IMPORTANT:** This refrigerator is designed for indoor household use only.

To ensure proper ventilation for your refrigerator, allow for 1/2" (1.27 cm) of space on each side and at the top. Allow for 2" (5.08 cm) of space behind the refrigerator. If your refrigerator has an ice maker, allow extra space at the back for the water line connections. When installing your refrigerator next to a fixed wall, leave a 2" (5.08 cm) minimum space on each side (depending on your model) to allow the doors to swing open.

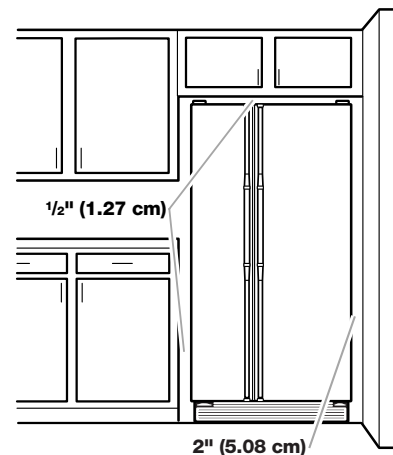



## NOTES:

- This refrigerator is intended for use in a location where the temperature ranges from a minimum of 55°F (13°C) to a maximum of 110°F (43°C). The preferred room temperature range for optimum performance, which reduces electricity usage and provides superior cooling, is between 60°F (15°C) and 90°F (32°C). It is recommended that you do not install the refrigerator near a heat source, such as an oven or radiator.
- Normal minimum cabinet cut-out width required for product installation is 36" (91.44 cm). However, if the product is placed against an extended wall and the ability to remove the crisper pans is desired, an additional 18" (45.72 cm) of cabinet width is required, so a total cabinet opening width of 54" (137.16 cm) is recommended.

## Electrical Requirements

### ⚠ WARNING



#### Electrical Shock Hazard

Plug into a grounded 3 prong outlet.

Do not remove ground prong.

Do not use an adapter.

Do not use an extension cord.

Failure to follow these instructions can result in death, fire, or electrical shock.

Before you move your refrigerator into its final location, it is important to make sure you have the proper electrical connection.

### Recommended Grounding Method

A 115 volt, 60 Hz, AC only, 15- or 20-amp fused, grounded electrical supply is required. It is recommended that a separate circuit serving only your refrigerator be provided. Use an outlet that cannot be turned off by a switch. Do not use an extension cord.

**NOTE:** Before performing any type of installation or cleaning, or removing a light bulb, turn cooling off or turn the control (Thermostat, Refrigerator or Freezer Control depending on the model) to OFF, and then disconnect the refrigerator from the electrical source. When you are finished, reconnect the refrigerator to the electrical source and turn cooling on or reset the control (Thermostat, Refrigerator or Freezer Control depending on the model) to the desired setting. See "Using the Controls" in the User Instructions, User Guide, or Use & Care Guide.

# REFRIGERATOR USE

## Ensuring Proper Air Circulation

In order to ensure proper temperatures, you need to permit air to flow between the two sections. Cold air enters the bottom of the freezer section and moves up. It then enters the refrigerator section through the top vent. Air then returns to the freezer as shown.

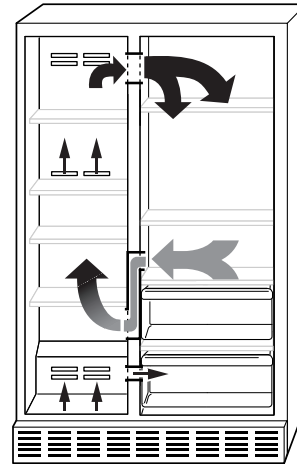

Do not block any airflow vents. If the vents are blocked, airflow will be obstructed and temperature and moisture problems may occur.

**IMPORTANT:** Because air circulates between both sections, any odors formed in one section will transfer to the other. You must thoroughly clean both sections to eliminate odors. To avoid odor transfer and drying out of food, wrap or cover foods tightly.

## Using the Controls

For your convenience, your refrigerator controls are preset at the factory. When you first install your refrigerator, make sure that the controls are still preset. The Refrigerator Control and the Freezer Control should both be set to the "mid-settings."

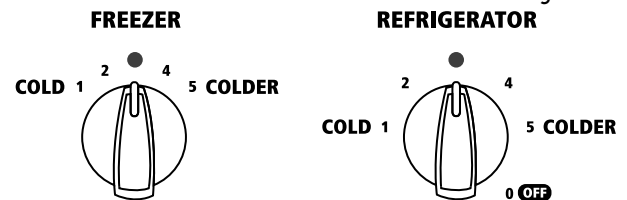

### IMPORTANT:

- Your product will not cool when the REFRIGERATOR Control is set to OFF.
- The Refrigerator Control adjusts the refrigerator compartment temperature. The Freezer Control adjusts the freezer compartment temperature. Settings to the left of the mid-setting make the temperature less cold. Settings to the right of the mid-setting make the temperature colder.
- Wait 24 hours before you put food into the refrigerator. If you add food before the refrigerator has cooled completely, your food may spoil.

**NOTE:** Adjusting the Refrigerator and Freezer Controls to a higher (colder) than recommended setting will not cool the compartments any faster.

---

## Adjusting Controls

---

Give the refrigerator time to cool down completely before adding food. It is best to wait 24 hours before you put food into the refrigerator. The settings indicated in the previous section should be correct for normal household refrigerator usage. The controls are set correctly when milk or juice is as cold as you like and when ice cream is firm.

- Turn the control right (clockwise) to make the compartment colder.
- Turn the control left (counterclockwise) to make it less cold.
- To turn the cooling system off, turn the Refrigerator Control counterclockwise until it reaches the OFF position.

If you need to adjust temperatures in the refrigerator or freezer, use the settings listed in the chart below as a guide. Wait at least 24 hours between adjustments.

CONDITION/REASON:	ADJUSTMENT:
REFRIGERATOR too warm	REFRIGERATOR Control one setting higher
FREEZER too warm/ too little ice	FREEZER Control one setting higher
REFRIGERATOR too cold	REFRIGERATOR Control one setting lower
FREEZER too cold	FREEZER Control one setting lower

---

## REFRIGERATOR FEATURES

Your model may have some or all of these features.

### Important information to know about glass shelves and covers:

Do not clean glass shelves or covers with warm water when they are cold. Shelves and covers may break if exposed to sudden temperature changes or impact, such as bumping. Tempered glass is designed to shatter into many small, pebble-size pieces. This is normal. Glass shelves and covers are heavy. Use both hands when removing them to avoid dropping.

### Refrigerator Shelves (number of shelves varies by model)

Store similar foods together and adjust the shelves to fit different heights. This reduces the time the refrigerator door is open and saves energy.

#### To Remove and Replace a Shelf:

1. Pull the shelf forward to the stop. Tilt the front of the shelf up. Lift to remove from the shelf supports.

2. Replace the shelf/frame by aligning the shelf with the shelf supports. Slide the shelf onto the shelf supports. Be sure that the shelf is securely in position.

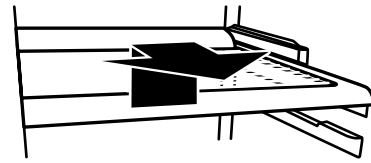

### Deli Drawer (on some models)

The deli drawer stores raisins, nuts, spreads, and other small items at normal refrigerator temperatures.

#### To Remove and Replace the Deli Drawer:

1. Remove the deli drawer by sliding it straight out to the stop. Lift the front and rear of the drawer up and out of the shelf supports. Tilt the drawer sideways to remove it from the refrigerator compartment.
2. Replace the deli drawer by sliding it back past the stop and pushing it into place.

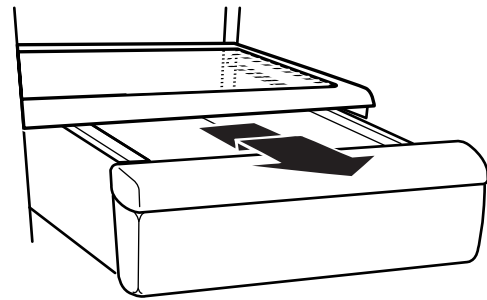

### Convertible Vegetable/Meat Drawer, Crisper and Covers (on some models)

#### Crisper and Convertible Vegetable/Meat Drawers

#### To Remove and Replace Drawers:

1. Slide crisper or meat drawer straight out to the stop. Lift the front of drawer with one hand while supporting the bottom of drawer with the other hand and slide the drawer out the rest of the way.
2. Replace the crisper or meat drawer by sliding it back in fully past the drawer stop.

#### Crisper and Convertible Vegetable/Meat Drawer Covers

#### To Remove and Replace Covers:

1. Remove the crisper and meat drawer. Press up in center of crisper glass insert until it rises above the plastic frame. Holding the crisper glass firmly, slowly slide the glass insert forward to remove. Lift crisper cover frame and remove. Repeat steps to remove the meat drawer cover.

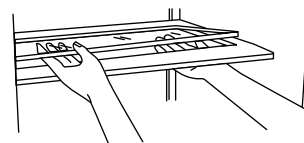

- Replace back of meat drawer cover frame into supports or slides on side walls of the refrigerator and lower or slide the front of the cover frame into place. Slide rear of glass insert into cover frame and lower front into place. Repeat steps to replace the crisper cover.

## Convertible Vegetable/Meat Drawer Temperature Control

(on some models)

The convertible vegetable/meat drawer can be adjusted to properly chill meats or vegetables. The air inside the pan is cooled to avoid "spot" freezing and can be set to keep meats at the National Livestock and Meat Board recommended storage temperatures of 28° to 32°F (-2° to 0°C).

**IMPORTANT:** To extend freshness, wrap meats in airtight, moisture-proof materials before storing. Always store meat as recommended.

### Adjusting the Control:

- Move the control to the right (colder) or to the left (less cold) as desired.

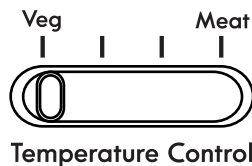

**To store vegetables:** Set the control to VEG (all the way to the left) to store vegetables at their optimal storage temperatures (which need to be warmer than those for meat).

**IMPORTANT:** If food starts to freeze, move the control to the left (less cold), toward the VEG setting. Remember to wait 24 hours between adjustments. Doing so gives the temperature of the food time to change.

### Meat Storage Guide

Store most meat in original wrapping as long as it is airtight and moisture-proof. Rewrap if necessary. See the following chart for storage times. When storing meat longer than the times given, freeze the meat.

Fresh fish or shellfish.....	use same day as purchased
Chicken, ground beef, variety meat (liver, etc.).....	1-2 days
Cold cuts, steaks/roasts .....	3-5 days
Cured meats.....	7-10 days
Leftovers - Cover leftovers with plastic wrap, aluminum foil, or plastic containers with tight lids.	

## Crisper Humidity Control

(on some models)

You can control the amount of humidity in the moisture-sealed crisper. Adjust the control to any setting between FRUIT [-] and VEGETABLES [+].

Fruit | | | | | | | Vegetables  
 ⊖ Humidity Control ⊕

FRUIT [-] (open) lets moist air out of the crisper for best storage of fruits and vegetables with skins.

- Fruit: Wash, let dry and store in refrigerator in plastic bag or crisper. Do not wash or hull berries until they are ready to use. Sort and keep berries in original container in crisper, or store in a loosely closed paper bag on a refrigerator shelf.
- Vegetables with skins: Place in plastic bag or plastic container and store in crisper.

VEGETABLES [+] (closed) keeps moist air in the crisper for best storage of fresh, leafy vegetables.

- Leafy vegetables: Wash in cold water, drain and trim or tear off bruised and discolored areas. Place in plastic bag or plastic container and store in crisper.

## FREEZER FEATURES

Your model may have some or all of these features.

### Frozen Food Storage Guide

Storage times will vary according to the quality and type of food, the type of packaging or wrap used (should be airtight and moisture-proof), and the storage temperature. Ice crystals inside a sealed package are normal. This simply means that moisture in the food and air inside the package have condensed, creating ice crystals.

Put no more unfrozen food into the freezer than will freeze within 24 hours (no more than 2 to 3 lbs of food per cubic foot [907 to 1,350 g per 28 L] of freezer space). Leave enough space in the freezer for air to circulate around packages. Be certain to leave enough room for the door to close tightly.

For more information on preparing food for freezing, check a freezer guide or reliable cookbook.

## Freezer Shelf

(number of shelves varies by model)

### To Remove and Replace the Shelf:

- Slide the shelf to one side. Tilt the shelf upward to remove the shelf from the support holes. To remove the other side from the support holes, pull the shelf upward and in the opposite direction.
- Replace the shelf by inserting the left side of the shelf into the support holes. Lower the right side of the shelf and insert into support holes.

**NOTE:** Be sure that both sides of the shelf are positioned evenly in the shelf support holes and the shelf is secure.

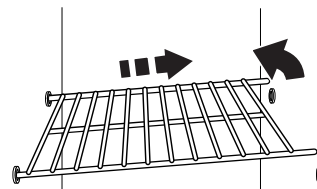

---

## Freezer Bin

(on some models)

The freezer bin can be used to store bags of frozen fruits and vegetables that may slide off freezer shelves.

### To Remove and Replace the Freezer Bin:

1. Remove the bin by sliding it out to the stop. Lift the front to slide the bin out the rest of the way.

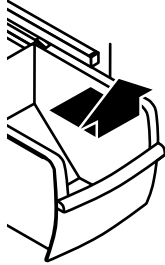

2. Replace the bin by positioning it on the rails. Lift the bin front slightly while pushing it in fully past the stops.

---

## DOOR FEATURES

Your model may have some or all of these features.

### Door Bins

(on some models)

#### To Remove and Replace the Bins:

1. Remove the bin by lifting it and pulling it straight out.
2. Replace the bin by sliding it in above the desired supports and pushing it down until it stops.

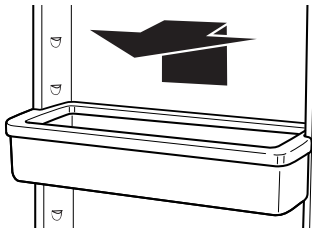

---

### Door Rails or Bins

(on some models)

The door rails or bins may be removed for easier cleaning.

---

#### Snap-On Door Rails or Bins

#### To Remove and Replace the Rails or Bins:

1. Remove the rails or bins by pushing in slightly on the front of the bracket while pulling out on the inside tab. Repeat these steps for the other end of the rail or bin.
2. Replace the rails or bins by aligning the ends of the brackets with the buttons on the sides of the door liner. Firmly snap bracket onto the tabs above the shelf as shown.

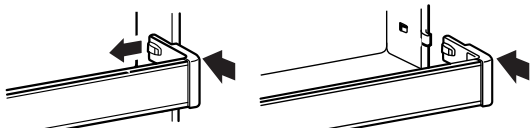

---

### Drop-In Door Rails

#### To Remove and Replace the Rails:

1. Remove the rails by pulling straight up on each end of the rail.
2. Replace the rails by sliding the shelf rail into the slots on the door and pushing the rail straight down until it stops.

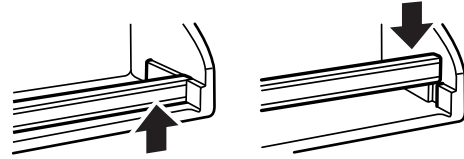

---

## REFRIGERATOR CARE

### Cleaning

#### ⚠ WARNING



#### Explosion Hazard

Use nonflammable cleaner.

Failure to do so can result in death, explosion, or fire.

Both the refrigerator and freezer sections defrost automatically. However, clean both compartments about once a month to avoid buildup of odors. Wipe up spills immediately.

#### To Clean Your Refrigerator:

1. Unplug refrigerator or disconnect power.
2. Remove all removable parts from inside, such as shelves, crispers, etc.
3. Hand wash, rinse, and dry removable parts and interior surfaces thoroughly. Use a clean sponge or soft cloth and a mild detergent in warm water.
  - Do not use abrasive or harsh cleaners such as window sprays, scouring cleansers, flammable fluids, cleaning waxes, concentrated detergents, bleaches or cleansers containing petroleum products on plastic parts, interior and door liners or gaskets. Do not use paper towels, scouring pads, or other harsh cleaning tools. These can scratch or damage materials.
  - To help remove odors, you can wash interior walls with a mixture of warm water and baking soda (2 tbs to 1 qt [26 g to 0.95 L] of water).
4. Determine whether your refrigerator exterior is painted metal, Ultra Satin™ (stainless look) finish, brushed aluminum or stainless steel, and choose the appropriate cleaning method.

**NOTE:** Ultra Satin™ (stainless look) finish has a smooth, uniform color with a glossy finish that resists fingerprints. Stainless steel has a distinct grainy texture with variation in color that is natural to steel.

**Painted metal:** Wash exteriors with a clean sponge or soft cloth and a mild detergent in warm water. Do not use abrasive or harsh cleaners, or cleaners designed for stainless steel. Dry thoroughly with a soft cloth. Additionally, to avoid damage to painted metal exteriors, apply appliance wax (or auto paste wax) with a clean, soft cloth. Do not wax plastic parts.

**Brushed aluminum:** Wash with a clean sponge or soft cloth and a mild detergent in warm water. Do not use abrasive or harsh cleaners, or cleaners designed for stainless steel. Dry thoroughly with a soft cloth.

**Ultra Satin™ (stainless look) finish:** Wash with a clean sponge or soft cloth and a mild detergent in warm water. Do not use abrasive or harsh cleaners, or cleaners designed for stainless steel. Dry thoroughly with a soft cloth.

**Stainless steel finish:** Wash with a clean sponge or soft cloth and a mild detergent in warm water. Do not use abrasive or harsh cleaners. Dry thoroughly with a soft cloth.

- To keep your stainless steel refrigerator looking like new and to remove minor scuffs or marks, it is suggested that you use the manufacturer's approved Stainless Steel Cleaner and Polish. To order the cleaner, see "Accessories."

**IMPORTANT:** This cleaner is for stainless steel parts only!

- Do not allow the Stainless Steel Cleaner and Polish to come into contact with any plastic parts such as the trim pieces, dispenser covers or door gaskets. If unintentional contact does occur, clean plastic part with a sponge and mild detergent in warm water. Dry thoroughly with a soft cloth.
5. If your model has a touch screen display on the dispenser panel, clean the screen using a soft, lint-free cloth. Mix a mild detergent with water, then use the mixture to dampen the cloth and gently wipe the screen.
    - To avoid unintentionally changing settings, make sure the refrigerator is unplugged or the power is disconnected before wiping the screen.
    - Do not over-saturate the cloth. Do not spray or wipe liquids directly onto the screen. Do not use abrasive or harsh cleaners such as window sprays, scouring cleansers, flammable fluids, cleaning waxes, concentrated detergents, nail polish remover, bleaches or cleansers containing petroleum products. Do not use paper towels, scouring pads, or other harsh cleaning tools. These can scratch or damage materials.
  6. There is no need for routine condenser cleaning in normal home operating environments. If the environment is particularly greasy or dusty, or there is significant pet traffic in the home, the condenser should be cleaned every 2 to 3 months to ensure maximum efficiency.

If you need to clean the condenser:

    - Remove the base grille. See "Base Grille" graphic or "Base Grille" section.
    - Use a vacuum cleaner with a soft brush to clean the grille, the open areas behind the grille and the front surface area of the condenser.
    - Replace the base grille when finished.
  7. Plug in refrigerator or reconnect power.

---

## Lights

The interior lights are LEDs that cannot be changed.

- If the interior lights do not illuminate when either door is opened, call for assistance or service. See either the front cover or the Warranty for contact information.

---

## Power Interruptions

If the power will be out for 24 hours or less, keep the door or doors closed (depending on your model) to help food stay cold and frozen.

If the power will be out for more than 24 hours, do one of the following:

- Remove all frozen food and store it in a frozen food locker.
- Place 2 lbs (907 g) of dry ice in the freezer for every cubic foot (28 L) of freezer space. This will keep the food frozen for 2 to 4 days.
- If neither a food locker nor dry ice is available, consume or can perishable food at once.

**REMEMBER:** A full freezer stays cold longer than a partially filled one. A freezer full of meat stays cold longer than a freezer full of baked goods. If you see that food contains ice crystals, it may be refrozen, although the quality and flavor may be affected. If the condition of the food is poor, dispose of it.

---

## Vacation and Moving Care

---

### Vacations

---

#### If You Choose to Leave Refrigerator On While You Are Away:

1. Use up any perishables and freeze other items.
2. If your refrigerator has an automatic ice maker and is connected to the household water supply, turn off the water supply to the refrigerator. Property damage can occur if the water supply is not turned off.
3. If you have an automatic ice maker, turn off the ice maker.

**NOTE:** Depending on your model, raise the wire shutoff arm to OFF (up) position or press the switch to OFF (right).
4. Empty the ice bin.

#### If You Choose to Turn Refrigerator Off Before You Leave:

1. Remove all food from the refrigerator.
2. If your refrigerator has an automatic ice maker:
  - Turn off the water supply to the ice maker at least one day ahead of time.
  - When the last load of ice drops, raise the wire shutoff arm to the OFF (up) position or move the switch to the OFF (right) setting.
3. Depending on the model, turn the Refrigerator Control to OFF or turn cooling off. See "Using the Controls" in the User Instructions, User Guide, or Use & Care Guide.
4. Clean refrigerator, wipe it, and dry well.
5. Tape rubber or wood blocks to the tops of both doors to prop them open far enough for air to get in. This stops odor and mold from building up.

---

## Moving

---

When you are moving your refrigerator to a new home, follow these steps to prepare it for the move.

1. If your refrigerator has an automatic ice maker:
  - Turn off the water supply to the ice maker at least one day ahead of time.
  - Disconnect the water line from the back of the refrigerator.
  - When the last load of ice drops, raise the wire shutoff arm to the OFF (up) position or move the switch to the OFF (right) setting.
2. Remove all food from the refrigerator and pack all frozen food in dry ice.
3. Empty the ice bin.
4. Depending on the model, turn the Refrigerator Control to OFF or turn cooling off. See “Using the Controls” in the User Instructions, User Guide, or Use & Care Guide.

5. Unplug refrigerator.
6. Clean, wipe, and dry thoroughly.
7. Take out all removable parts, wrap them well, and tape them together so they don't shift and rattle during the move.
8. Depending on the model, raise the front of the refrigerator so it rolls more easily OR screw in the leveling legs so they don't scrape the floor. See “Adjust the Doors” or “Door Removal, Leveling and Alignment.”
9. Tape the doors closed and tape the power cord to the back of the refrigerator.

When you get to your new home, put everything back and refer to the Installation Instructions for preparation instructions. Also, if your refrigerator has an automatic ice maker, remember to reconnect the water supply to the refrigerator.

---

## PROBLEM SOLVER

First try the solutions suggested here or visit our website to possibly avoid the cost of a service call.

**⚠ WARNING**



**Electrical Shock Hazard**

Plug into a grounded 3 prong outlet.  
Do not remove ground prong.  
Do not use an adapter.  
Do not use an extension cord.

Failure to follow these instructions can result in death, fire, or electrical shock.

---

### GENERAL OPERATION      Possible Causes and/or Recommended Solutions

---

#### Refrigerator will not operate

- **Not connected to an electrical supply** - Plug the power cord into a grounded 3 prong outlet. Do not use an extension cord.
- **No power to the electrical outlet** - Plug in a lamp to see if the outlet is working.
- **Household fuse has blown or circuit breaker has tripped** - Replace the fuse or reset the circuit breaker. If the problem continues, contact a licensed electrician.
- **Control or cooling is not turned on** - Turn on the refrigerator control, or turn cooling on. See “Using the Controls.”
- **New installation** - Following installation, allow 24 hours for the refrigerator and freezer to cool completely.

**NOTE:** Adjusting the temperature control(s) to the coldest setting will not cool either compartment (refrigerator or freezer) more quickly.

---

**GENERAL OPERATION Possible Causes and/or Recommended Solutions**

---

**Motor seems to run too much** ■ **Your new refrigerator has an energy-efficient motor** - The refrigerator may run longer than you're used to, because the compressor and fans operate at lower speeds that are more energy-efficient. This is normal.

**NOTE:** Your refrigerator may run even longer if the room is warm, a large load of food is added, the doors are opened often, or if a door has been left open.

---

**Refrigerator seems noisy** The compressor in your new refrigerator regulates temperature more efficiently and uses less energy than older models. During various stages of operation, you may hear normal operating sounds that are unfamiliar.

**The following noises are normal:**

- **Popping** - Heard when the inside walls contract/expand, especially during initial cooldown.
- **Pulsating/Whirring** - Heard when the fans/compressor adjust to optimize performance during normal operation.
- **Rattling** - Heard when water passes through the water line, or due to the flow of refrigerant. Rattling may also come from items placed on top of the refrigerator.
- **Water running or gurgling** - Heard when ice melts during the defrost cycle and water runs into the drain pan.
- **Sizzling** - Heard when water drips onto the heater during the defrost cycle.

---

**Temperature is too warm** ■ **New installation** - Following installation, allow 24 hours for the refrigerator and freezer to cool completely.

**NOTE:** Adjusting the temperature control(s) to the coldest setting will not cool either compartment (refrigerator or freezer) more quickly.

- **Doors are opened often or not closed completely** - This allows warm air to enter the refrigerator. Minimize door openings, keep the doors fully closed, and make sure both doors are properly sealed.
- **Air vents are blocked** - Remove items that are immediately in front of the vents.
- **Large amount of warm food recently added** - Allow several hours for the refrigerator to return to its normal temperature.
- **Controls are not set correctly for the surrounding conditions** - Adjust the controls to a colder setting. Check the temperature again in 24 hours.

---

**Temperature is too cold** ■ **Controls are not set correctly for the surrounding conditions** - Adjust the controls to a warmer setting. Check the temperature again in 24 hours.

- **Top refrigerator shelf is colder than lower shelves** - On some models, air from the freezer enters the refrigerator compartment through vents near the top refrigerator shelf. As a result, the top shelf can be slightly colder than lower shelves.
- **Air vents are blocked** - Remove items that are immediately in front of the vents.

---

**Interior moisture buildup** **NOTE:** Some moisture buildup is normal. Clean with a soft dry cloth.

- **Room is humid** - A humid environment contributes to moisture buildup. Only use the refrigerator in an indoor location, with as little humidity as possible.
- **Doors are opened often or not closed completely** - This allows humid air to enter the refrigerator. Minimize door openings, keep the doors fully closed, and make sure both doors are properly sealed.

---

**Interior lights do not work** ■ **Doors have been open for an extended period of time** - Close the doors to reset the lights.

- **Light bulb is loose in the socket or has burned out** - On models with incandescent interior light bulbs, tighten or replace the bulb. See "Lights."

**NOTE:** On models with LED lights, call for assistance or service if the interior lights do not illuminate when either door is opened. See either the front cover or the Warranty for contact information.

---

## ⚠ WARNING



### Explosion Hazard

Use nonflammable cleaner.

Failure to do so can result in death, explosion, or fire.

---

## DOORS AND LEVELING

### Possible Causes and/or Recommended Solutions

<b>Doors are difficult to open</b>	■ <b>Gaskets are dirty or sticky</b> - Clean the gaskets and contact surfaces with mild soap and warm water. Rinse and dry with a soft cloth.
<b>Doors will not close completely</b>	■ <b>Door is blocked open</b> - Move food packages away from the door. Make sure all bins and shelves are in their correct positions. Make sure all packaging materials have been removed.
<b>Doors appear to be uneven</b>	■ <b>Doors need to be aligned, or refrigerator needs to be leveled</b> - See the leveling and door alignment instructions.
<b>Refrigerator rocks and is not stable</b>	■ <b>Refrigerator is not level</b> - To stabilize the refrigerator, remove the base grille and lower the leveling feet until they touch the floor. See the leveling and door alignment instructions.

---

## ACCESSORIES

### Replacement Parts:

To order stainless steel cleaner or replacement filters, call 1-800-4-MY-HOME® and ask for the appropriate part number listed below or contact your authorized Kenmore dealer.

### Stainless Steel Cleaner and Polish:

Order Part #D22 M40083 R



---

## Notes